

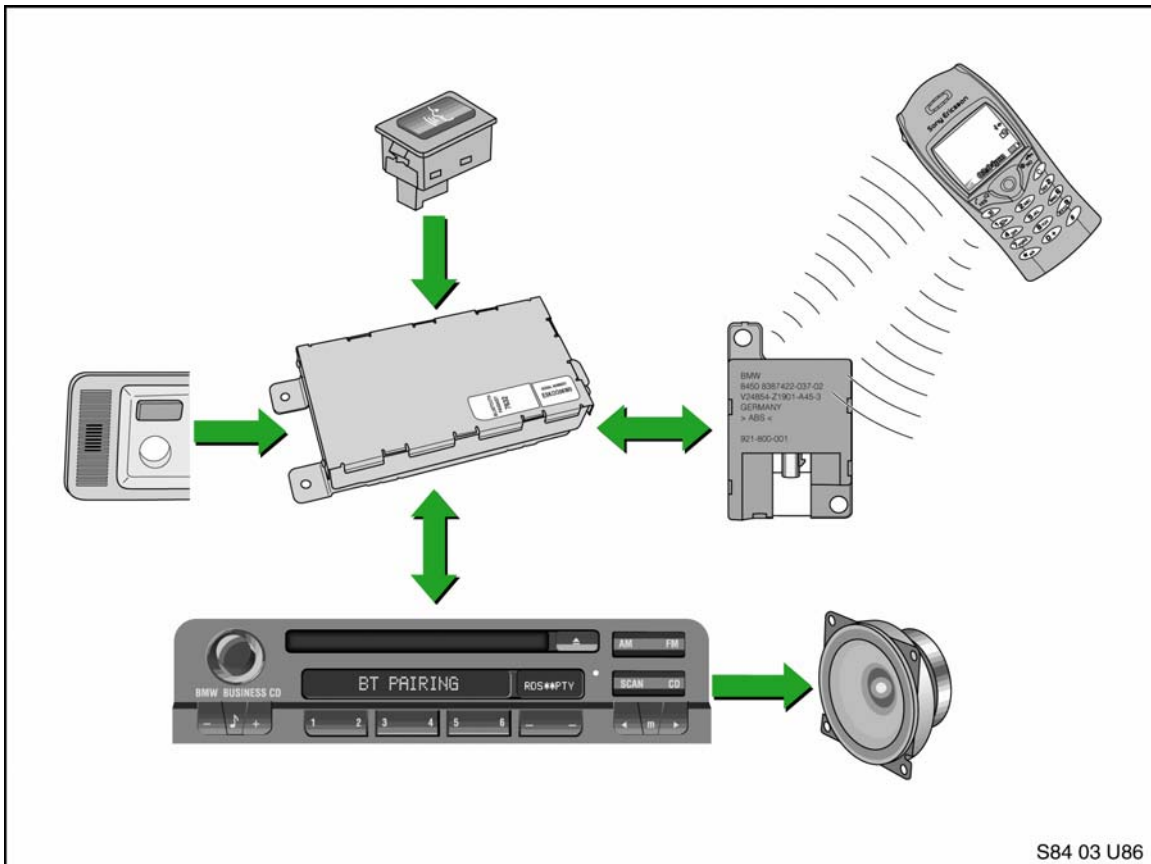

# BMW Universal Bluetooth™ Hands-Free System (ULF) Owner's Manual



## **Universal Bluetooth™ Hands-Free System (ULF)**

Dear BMW Owner:

Congratulations on your purchase of the BMW Universal Bluetooth™ Hands-Free System (ULF) for your BMW Group vehicle and for you! The BMW Universal Bluetooth™ Hands-Free System will provide an additional convenience feature for you and your passengers.

To take full advantage of your BMW Universal Bluetooth™ Hands-Free System, we encourage you to take the time to read this manual thoroughly. This User's Manual is intended to familiarize you with the details of your Hands-Free System. You will receive important information regarding its operation, which will allow you to use all the functions quickly and in optimal fashion.

"Never use any electronic device or make any inputs while driving that may distract you from driving safely.

Pay attention to traffic laws and road conditions\situations. Safe vehicle operation is the driver's responsibility. Always wear your safety belt."

BMW of North America, LLC

# Universal Bluetooth™ Hands-Free System (ULF)

## **Contents**

Introduction	4
What is Bluetooth™?	4
Communication/Security	5
Data and Voice	5
Bluetooth™ Enabled Phones	5
Advantages of the ULF System	6
System Overview	6
ULF Control Module	6
Oddment Tray	7
Pairing Button	7
Bluetooth™ Antenna	7
System Operation	8
Initial Operation	8
Pairing Procedure	8
System Functions	12
Indicator Lamps	12
Adopting Telephone Book	12
Placing A Call	12
Receiving/Accepting a Call	13
Conducting a Call	14
Ending a Call	15
Transfer Active Call From Phone to ULF	15
Transfer Active Call From ULF to Phone	15
Linking Several Bluetooth™ Mobile Phones	16
Deleting Devices	16

## Universal Bluetooth™ Hands-Free System (ULF)

### Introduction

The BMW Universal Bluetooth™ Hands-Free System (ULF) utilizes Bluetooth™ wireless technology to enable a wireless connection to be established between a Bluetooth™ enabled mobile phone and the ULF Control Module installed in the vehicle. The combination of these components results in a new generation of in-vehicle phone system.

The ULF Control Module forms an interface that allows a mobile phone with the embedded Bluetooth™ wireless technology feature to be wirelessly integrated into the vehicle. For the first time BMW is introducing a new generation hands-free telephone system kit that provides the customer with the option of using various Bluetooth™ enabled mobile phones (a list of recommended phones is available from your BMW Center).

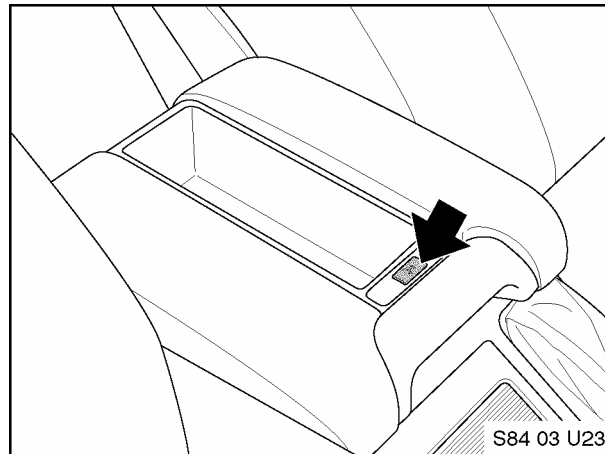

5 Series (E39) - With Oddment Tray

### What is Bluetooth™?

The name Bluetooth™ is derived from the Danish King Harald Bluetooth who lived in the 10th century. He was well known for his ability to unify his kingdom and today lends his name to a wireless technology standard that can connect/unify various electronic devices that are Bluetooth™ enabled and located within a short range (approx. 10 m or 32.8 ft) of each other.

Bluetooth™ wireless technology is a short-range radio frequency technology standard that allows several devices to communicate with each other simultaneously. The standard indicates that up to seven simultaneous connections can be established and maintained at one time, as long as the connected devices are within a range of 10 m (32.8 ft).

Note: The ULF system will allow four phones to be paired to the system at a time and only allow one phone to be connected at a time.

## Universal Bluetooth™ Hands-Free System (ULF)

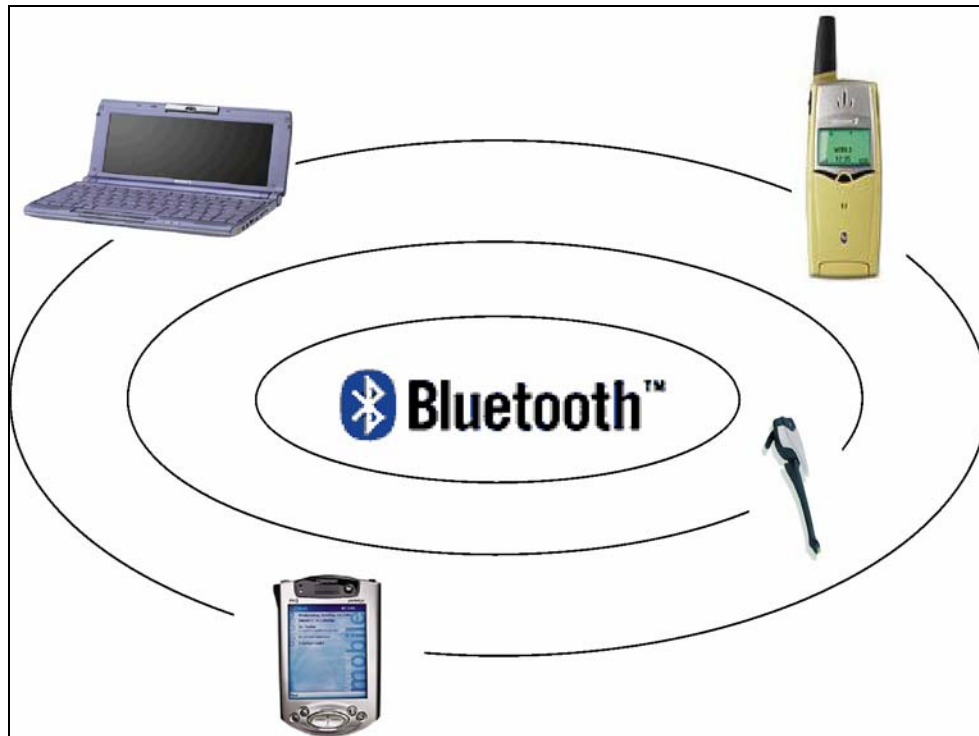

Wireless Communication

### Communication/Security

The system uses the license-free, global Industrial Scientific Medical band (ISM) at 2.45 GHz. This frequency range from 2.402 GHz to 2.480 GHz is subdivided into 79 channels with a 1 MHz bandwidth.

Signals transmitted through the airways can be scrambled and unscrambled to enhance communication security. With Bluetooth™ technology, communication frequencies are changed 1600 times per second to reduce the risk of interference or interception of the transmitted signal. The relatively small operating range of approx. 10 m (32.8 ft) also enhances the security of this technology, since tampering with the transmitted data is only possible when inside the 10 m (32.8 ft) wireless “network”.

To further enhance the security of this short-range wireless network the ULF system requires a pairing procedure to be carried out for each device that will be introduced into the network. As part of this procedure a required passkey must be entered once (during the initial pairing procedure) to establish a secure connection between the phone and the ULF Control Module.

### Data and Voice

Bluetooth™ was developed for the transmission of both voice as well as data. A bandwidth of approx. 1 MB/s is available for this purpose.

### Bluetooth™ Enabled Phones

Ideally all phones that are Bluetooth™ enabled should work with the ULF system, however not all phones utilize the same profiles and therefore may not be recognized by the ULF System. A list of recommended Bluetooth™ enabled phones is available from your BMW Center.

## Universal Bluetooth™ Hands-Free System (ULF)

### Advantages of the ULF System

- Once a phone is paired to the system it will be able to automatically connect to the Bluetooth™ wireless network of the vehicle, the next time it is introduced into the vehicle and the vehicle ignition is on.
- Up to four different Bluetooth™ phones can be paired to the system at one time, although only one phone can be wirelessly connected at any time.
- The phone does not need to be inserted into a phone specific cradle in order to be integrated into the vehicle.
- The phone can remain in a briefcase, purse, glove box, etc.; as long as it is turned on and located within the interior of the vehicle.
- The MFL buttons on the steering wheel can be utilized to place or receive a call, to scroll the phone book and select a number or activate voice recognition in order to dial a number via voice command.
- A voice recognition system is integrated into the ULF control module and can be activated by depressing the send/receive  button.
- The communications protocol of Bluetooth™ wireless technology is standardized irrespective of the manufacturer, this therefore allows various mobile telephones that utilize Bluetooth™ wireless technology and a recognized profile to be connected to the ULF System.

### System Overview

A ULF system consists of a control module, microphone, Bluetooth™ antenna, a stand-alone pairing (send/receive) button, or eject box with a coin tray insert.

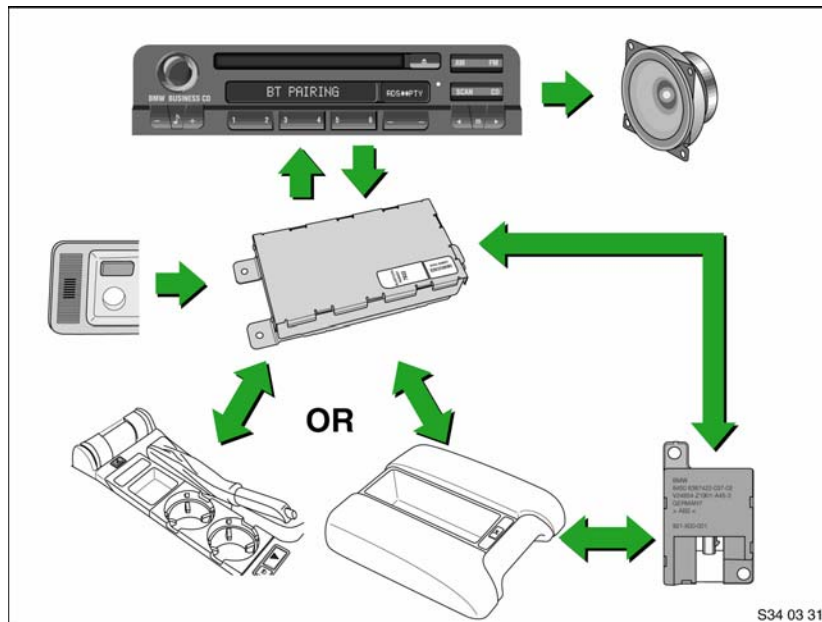

ULF System Overview

### ULF Control Module

The ULF module forms the interface between the Bluetooth™ mobile phone and the electronic system in the vehicle. The mobile phone with the embedded Bluetooth™ wireless technology is the transceiver, this requires that the phone

## Universal Bluetooth™ Hands-Free System (ULF)

be activated, paired and present within the vehicle network in order to place or receive a call in the vehicle.



### Oddment Tray

The oddment tray, which is connected to the ULF control module via the vehicles wiring harness, serves the purpose of:

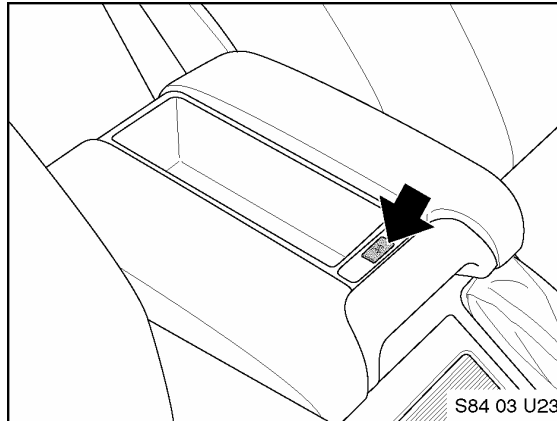
Housing the send/receive  or pairing button, which must be depressed to activate the pairing procedure between the phone and the control module.



### Pairing Button

A stand-alone send/receive  or pairing button is supplied for the 3 Series in order to retain the cup holders. The button provides the same function as the send/receive  button on the steering wheel, plus is the button that must be depressed to activate the pairing procedure between the phone and the control module.

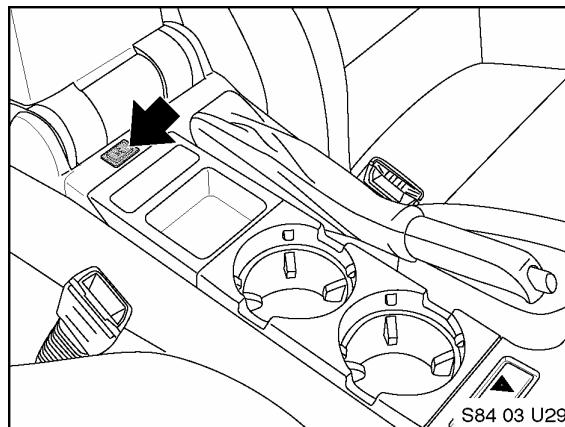

### Bluetooth™ Antenna

The Bluetooth™ antenna operates on a frequency of 2.45 GHz and is installed in the interior compartment of the vehicle. This antenna provides the wireless interface between the Bluetooth™ enabled phone and the ULF Control Module.

# Universal Bluetooth™ Hands-Free System (ULF)

## System Operation

### Initial operation

Prior to using the system for the first time, the Bluetooth™ mobile phone that is to be used must be paired with the ULF control module. This pairing procedure is necessary in order to assign the digital code of the mobile phone to the ULF control module installed in the vehicle. The pairing procedure is only required when a new phone is introduced to the ULF system for the very first time or the list of paired devices is cleared from the memory of the ULF module, it does not need to be performed every time the phone is used with the system.

After pairing, the mobile phone is recognized automatically by the ULF control module within 45 seconds after it is introduced into the vehicle and the ignition is turned on.

**Note:** Depending on the mobile phone manufacturer, particular care must be taken prior to initial operation to ensure that no headset is coupled with the mobile phone. Various devices may interpret the ULF control module as a headset and request deactivation of the headset. Please refer to the operating instructions of the mobile phone for detailed information.

### Pairing Procedure

The pairing procedure that must be initiated through the phone will differ corresponding to the different menu configurations of the various Bluetooth™ mobile phones on the market. The user's manual of the phone manufacturer should always be referenced for specific steps on how to activate the Bluetooth™ feature and to pair/link devices.

The following steps are generalized steps that should help in activating the Bluetooth™ function of most phones:

#### IN VEHICLE:

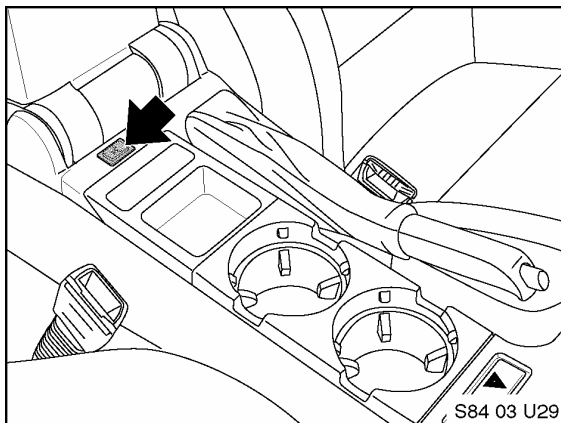

1. Depress the send /receive (pairing) button located in the center console, for at least 1 second prior to switching on the ignition and continue to hold the button down for approximately 2-3 seconds after the ignition is turned on.
2. Release the button.



## Universal Bluetooth™ Hands-Free System (ULF)

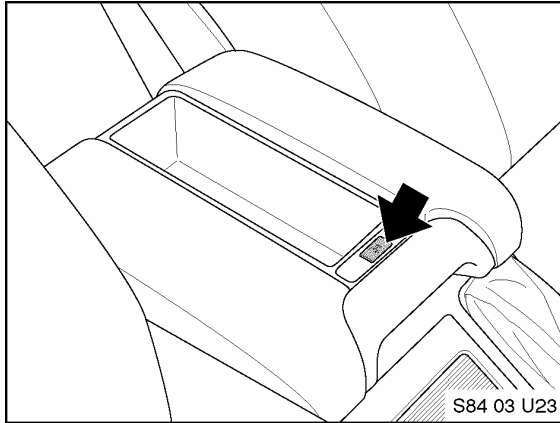

Note: The send/receive (pairing) button in 5 Series and X5 SAV is located on the oddment tray assembly in the center console.

3. Shortly after releasing the button on the Radio or Display Screen, the following message should be displayed:

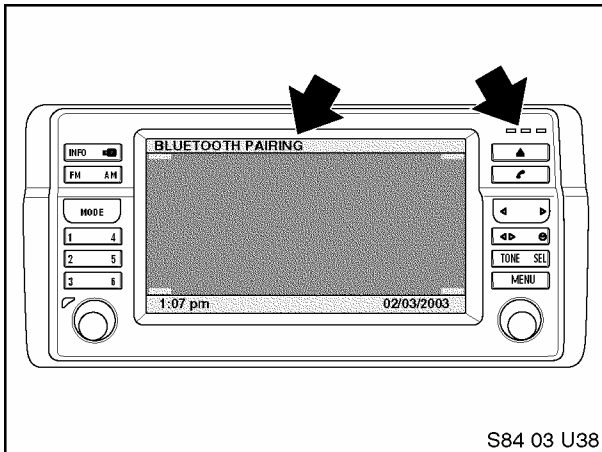

a. Display Screen:

- "Bluetooth Pairing" displayed.
- Green, Yellow and Red LEDs on the right side of the unit are flashing which indicates that the ULF is waiting for a signal from the Bluetooth™ device to be paired.

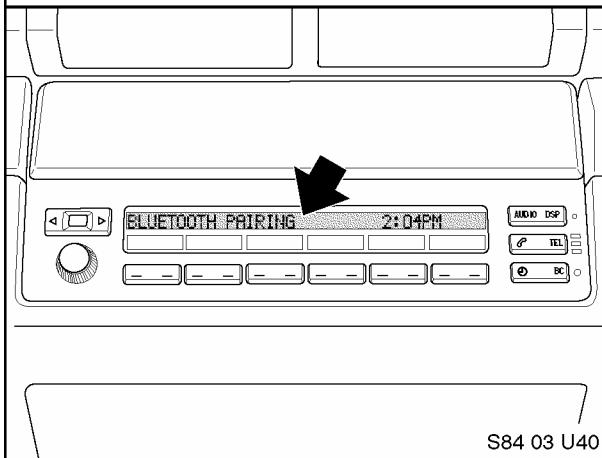

b. Radio Display (5 Series and X5 SAV):

- "Bluetooth Pairing" display which indicates that the ULF is searching for available Bluetooth™ devices.
- Green, Yellow and Red LEDs on the right side of the unit are flashing which indicates that the ULF is waiting for a signal from the Bluetooth™ device to be paired.

## Universal Bluetooth™ Hands-Free System (ULF)

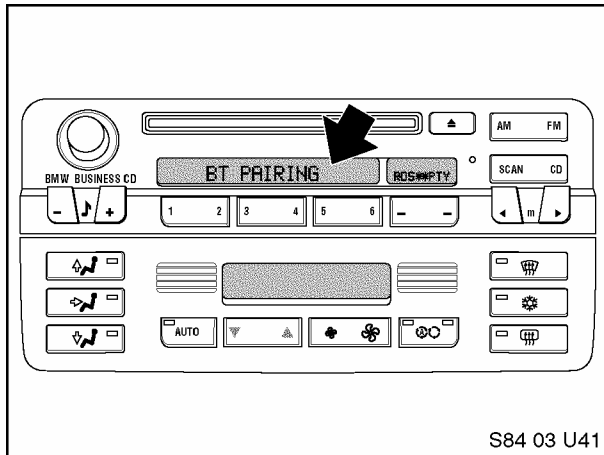

c. Radio Display (3 Series with CD or Cassette):

- “BT Pairing” display which indicates that the ULF is searching for available Bluetooth™ devices.

4. Activate the search function of the phone as indicated below.

### ON PHONE:

1. Locate the connection/settings menu and select Bluetooth™.
2. Select the response that will activate the Bluetooth™ feature of the phone.
3. Next select a menu option that will allow you to “Discover” or “Search” for active Bluetooth™ devices.
4. If the phone identifies/finds a device (named “BMW” followed by 5 digits) select it and follow the indicated steps to complete the pairing process.
5. Once the phone is successfully paired to the device cycle the vehicle ignition switch off and back on and the devices should wirelessly connect within 30 seconds. When the connection is established the phone will display a connection symbol.

*The following steps are an example of the pairing procedure that must be initiated to pair the Sony Ericsson T68i phone to the ULF Control Module.*

1. Press the menu button.
2. Select “Connect”.
3. Select option 3: “Bluetooth”.
4. Select option 4: “Options”.
5. Select option 1: “Operation mode” and set to “On” or “Automatic”.
6. Go back one step by pressing the red phone button several times.
7. Select option 3: “Discover”.
8. Mobile phone display shows ‘Searching’
9. Select “BMW .....” in upcoming list.
10. Select option 1: “Add to paired”.

## Universal Bluetooth™ Hands-Free System (ULF)

11. Enter the password (= ULF passkey) located on ULF Control Module that is in the rear of the vehicle or on the Passkey Reference Card.
  - Mobile phone display shows 'BMW ..... Pairing'
  - Mobile phone display shows 'Pairing Successful'
  - Display screen shows 'Pairing succeeded' for 3 seconds
12. Enter device name or accept the name that is automatically displayed.
13. Mobile phone display shows "Added to paired devices".
14. Exit menu by pressing the red phone/NO button.
15. Once the phone is successfully paired to the device cycle the ignition switch off and back on.

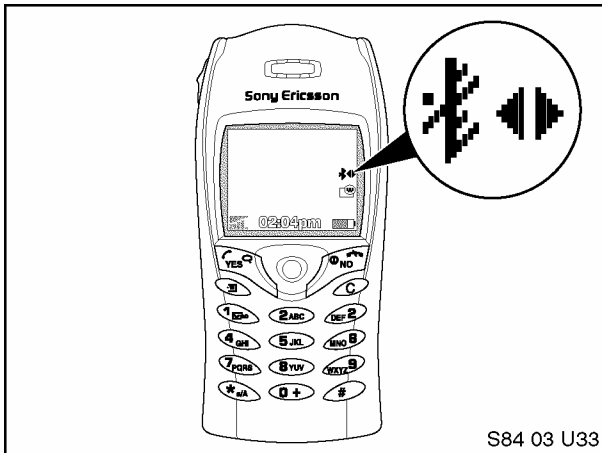

16. The devices should wirelessly connect within 30 seconds. The connection is established when the phone displays the symbols indicated, on the right side of the screen.

*Note: Shortly after turning on the ignition and the Bluetooth™ connection is identified, the phone may display a message asking if the connection should be established/accepted. The connection authorization request will always occur unless the setting on the phone is modified to allow automatic connection every time, please refer to the user's manual of the phone to determine how to change this setting.*

## Universal Bluetooth™ Hands-Free System (ULF)

### System Functions

The mobile phone must always be activated, paired and present within the Bluetooth™ network in order to place or receive a call through the vehicle.

#### Indicator lamps

The indicator lamps show the following:

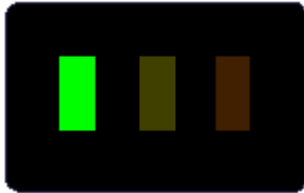

Active call (green light)

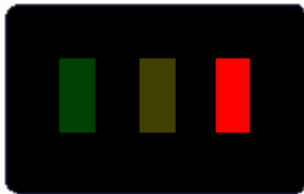

No mobile phone in range  
(steady red light)

No network (flashing red  
light)

#### Adopting Telephone Book

Depending on the type of Bluetooth™ mobile phone, the telephone book is either transferred automatically (ex. Nokia 6310, Sony Ericsson T68i) or manually (depending on software version of phone) by the user to the ULF control module. The address book is stored temporarily for the purpose of accessing/displaying stored phonebook information using the steering wheel controls or telephone menu selections available on the display screen or some radio displays.

If a manual transfer of the address book must be made, the ULF must be in setup mode for manual transfer. The corresponding data can then be transferred. If phonebook data is modified while the phone is wirelessly connected to the vehicle the changes will not be displayed in the vehicle if the phonebook is scrolled via the steering wheel or display screen, changes will only be transferred the next time the ignition is cycled.





#### Placing a Call

A call can be placed in several different ways:

1. Using the keypad or address book of the mobile phone and depressing the send button on the phone.

Note: Some phones may ask if the call is to remain within the phone. Refer to the users manual of the phone for specific instructions on disabling this feature.

## Universal Bluetooth™ Hands-Free System (ULF)

2. Depressing the R/T button on the steering wheel, then scrolling (using the  or  buttons) through the address book of the phone that is linked to the ULF, until the desired number is displayed on the radio or display screen and then depressing the send/receive  button on the steering wheel or center console to place the call.
3. Depressing the  button on the steering wheel until an audible “beep” is heard through the vehicle speakers, at this point a call can be placed by using the following voice commands:
  - “Dial number” or “Dial phone”
  - After the system asks for a number say the number  
Example: “123 456 7890”; the system will repeat the number requested once you stop speaking momentarily, the number may also be displayed depending on the vehicle and equipment/accessories installed.
  - “Dial”
  - Note: Once the dial command is given the number will be displayed on the display screen or radio; plus it will always be displayed on the mobile phone after a call is placed.
4. Briefly depressing the  button on the steering wheel will redial the last number dialed.  
For more information on using voice commands refer to the “Owner’s Manual for Voice Input System. The Convenient Alternative to Manual Control” (P/N 84 11 027 942)

### Receiving/Accepting a Call



The call ringer in the Bluetooth™ mobile phone is audible when an incoming call signal is received. At the same time, the signal is sent via the Bluetooth™ interface in the mobile phone to the Bluetooth™ antenna in the vehicle. The ULF receives the incoming ring/call signal via the Bluetooth™ antenna and mutes the radio. The incoming ring/tone signal is then also transmitted to the vehicle speakers.

The following options are available for accepting a call:

#### *3 Series without Display Screen:*



- Press send/receive  button on MFL (Steering Wheel)
- Press send/receive  button in the center console
- Press send/receive key on mobile phone

#### *5 Series and X5 SAV without Display Screen:*

- Press send/receive  button on MFL (Steering Wheel)
- Press send/receive key on radio
- Press send/receive  button on the oddment tray (Center Console)
- Press send/receive key on mobile phone

#### *Vehicles with Display Screen:*

## Universal Bluetooth™ Hands-Free System (ULF)

- Press send/receive  button on MFL (Steering Wheel)
- Press send/receive  button on the oddment tray (Center Console)
- Select the green phone symbol on the Display Screen.
- Press send/receive key on mobile phone

### Conducting a Call

If the call is accepted by pressing the send/receive key  on the Radio (5 series and X5 SAV), Display Screen, steering wheel or center console, it will be conducted via the hands free microphone and vehicle speakers.

*If a call is accepted by pressing the send/receive key on the mobile phone, the reaction will depend on the type of handset. In the majority of cases, however, the question appears:*

"Do you wish to use the mobile phone?"

Please refer to the operating instructions of the mobile phone for a detailed description of the operating procedure of the phone.

The hands-free function is activated after pressing the send/receive key. The incoming call is encoded (scrambled) via the Bluetooth™ interface in the mobile phone and sent to the Bluetooth™ antenna in the vehicle. The call is received by the ULF control module and output via the radio to the audio speakers.

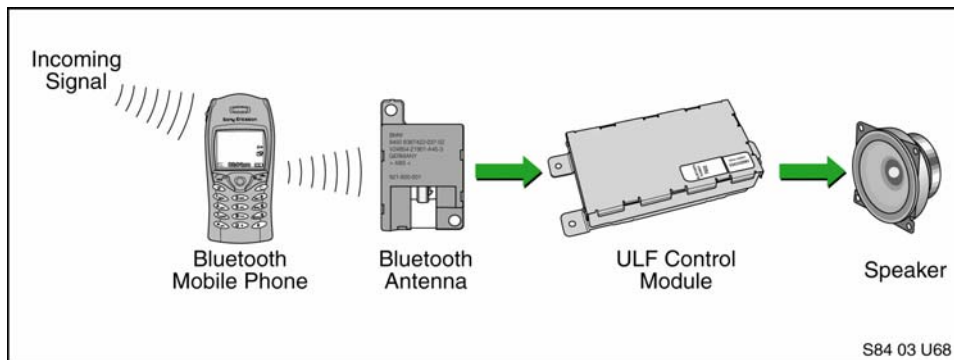

Since the ULF system provides a digital full-duplex hands-free operation, it is possible to simultaneously speak and listen to calls. An echo cancellation function prevents feedback when speaking into the microphone. The microphone audio signal is sent via a hardwire connection to the ULF control module. In the ULF module the received audio signal is scrambled via the Bluetooth™ module and transferred via the Bluetooth™ antenna to the mobile phone. The mobile phone then transmits the call via the phone antenna.

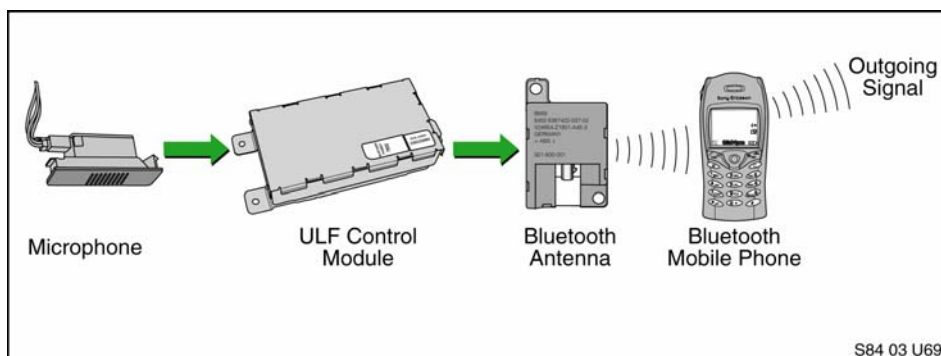

## Universal Bluetooth™ Hands-Free System (ULF)



### Ending a Call

The following options are available for ending a call:



#### *3 Series without Display Screen:*

- Press send/receive  button on MFL (Steering Wheel)
- Press send/receive  button in the center console
- Press send/receive key on mobile phone

#### *5 Series and X5 SAV without Display Screen:*

- Press send/receive  button on MFL (Steering Wheel)
- Press send/receive key on radio
- Press send/receive  button on the oddment tray (Center Console)
- Press send/receive key on mobile phone



#### *Vehicles with Display Screen:*

- Press send/receive  button on MFL (Steering Wheel)
- Press send/receive  button on the oddment tray (Center Console)
- Select the green phone symbol on the Display Screen.
- Press send/receive key on mobile phone

### Transfer Active Call From Phone to ULF

If a call is received or placed via the handset, it can be transferred into the vehicle once the phone is within the active Bluetooth™ network of the vehicle.

Call transfer procedure:

1. Ignition must be on
2. Bluetooth™ connection must be established .
3. Briefly depress the send/receive button  located in the center console.

**NOTE:** Some phones may automatically display a statement asking the user if the active call should be transferred to the ULF system shortly after the Bluetooth™ connection is established. If the request is acknowledged the call is automatically transferred into the vehicle/ULF system without having to depress the send/receive button .

### Transfer Active Call from ULF to Phone

If you are currently in an active call and you need to leave the vehicle the call can be transferred into the handset in several ways.

1. Ignition is turned off and you walk away from the vehicle. Once outside the 10 m (32.8 ft) range a message may be displayed on the phone asking if the current call should be maintained or ended, by maintaining the call it will be transferred to the handset.
2. Depending on the model of phone being used the call can be transferred to the handset by manually disconnecting from the Bluetooth™ network via

## Universal Bluetooth™ Hands-Free System (ULF)

the connections menu or selecting a transfer function in the settings menu of the phone (refer to the user's manual of the phone for more information).

### Linking Several Bluetooth™ Mobile Phones

Up to four Bluetooth™ mobile phones can be paired one after the other to the ULF control module. The pairing operation corresponds to the procedure described above.

The handset paired last has the highest priority. The telephone paired first will drop out of the list if a fifth Bluetooth™ mobile phone is paired.

**Note:** For incoming and outgoing calls, only the user connected first to the system can speak via the hands-free facility.

If two users enter the network or connection range simultaneously, only the user with the highest priority (the user last paired during the initial pairing procedure) will be able to use the hands-free function for incoming & outgoing calls. If the highest priority phone is turned off the phone with the next highest priority will be connected.

### Deleting Devices

The paired Bluetooth™ mobile phones can only be deleted as a single group from the ULF control module.

The pairing procedure must first be activated, and then the send/receive  button on the installed eject-box or the pairing button located at the rear of the center console must again be depressed for an additional 10 seconds after the "Bluetooth Pairing" message is displayed on the radio in order to clear the list of paired devices from the control module and the message "paired devices deleted" is displayed.